

SINGER
861A,862A,872A

SINGER

PARTS LIST

High speed

**Overedge and
Safety Stitch machines**

861A

862A

**872A
Series**

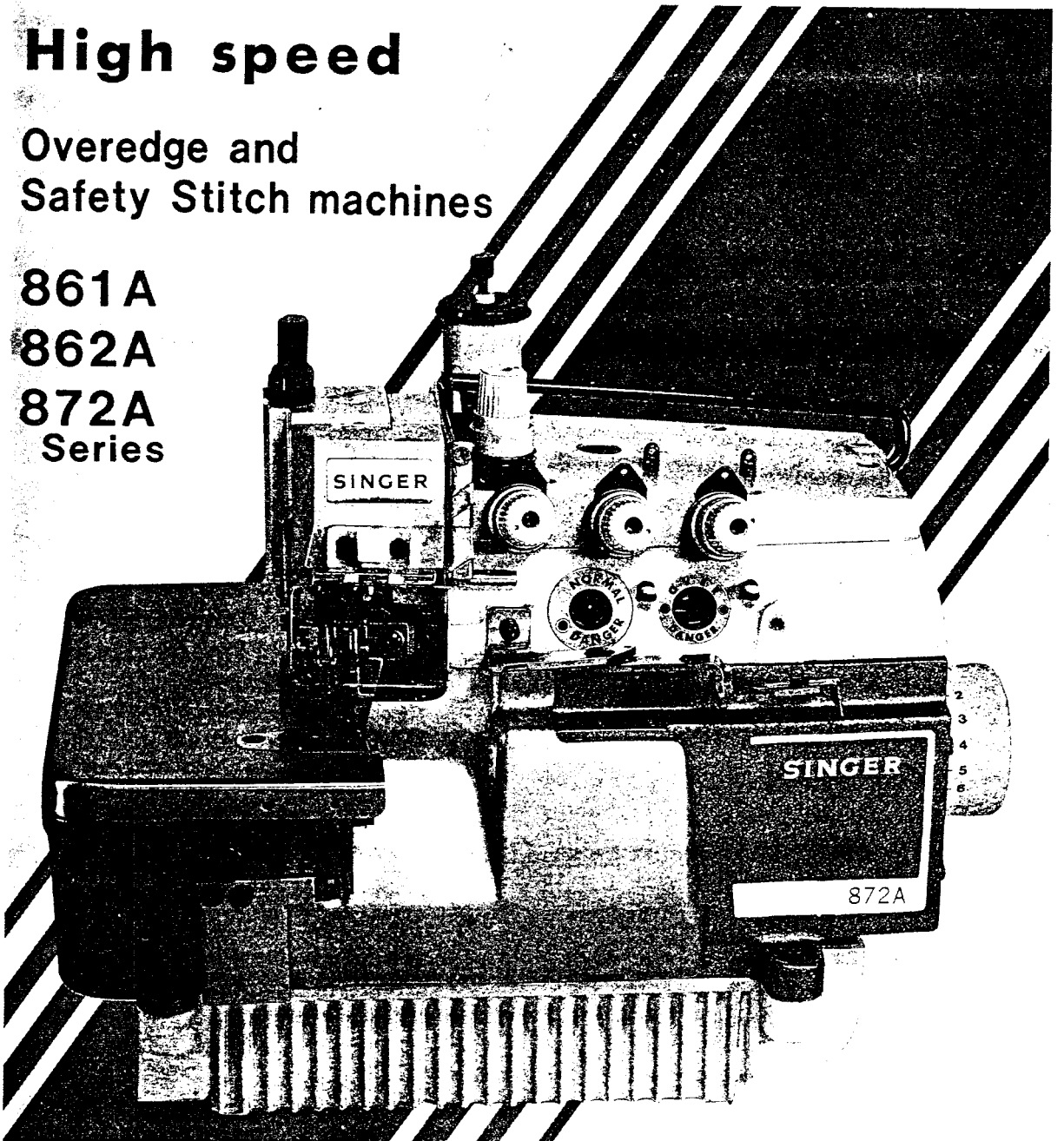

From the library of: Diamond Needle Corp

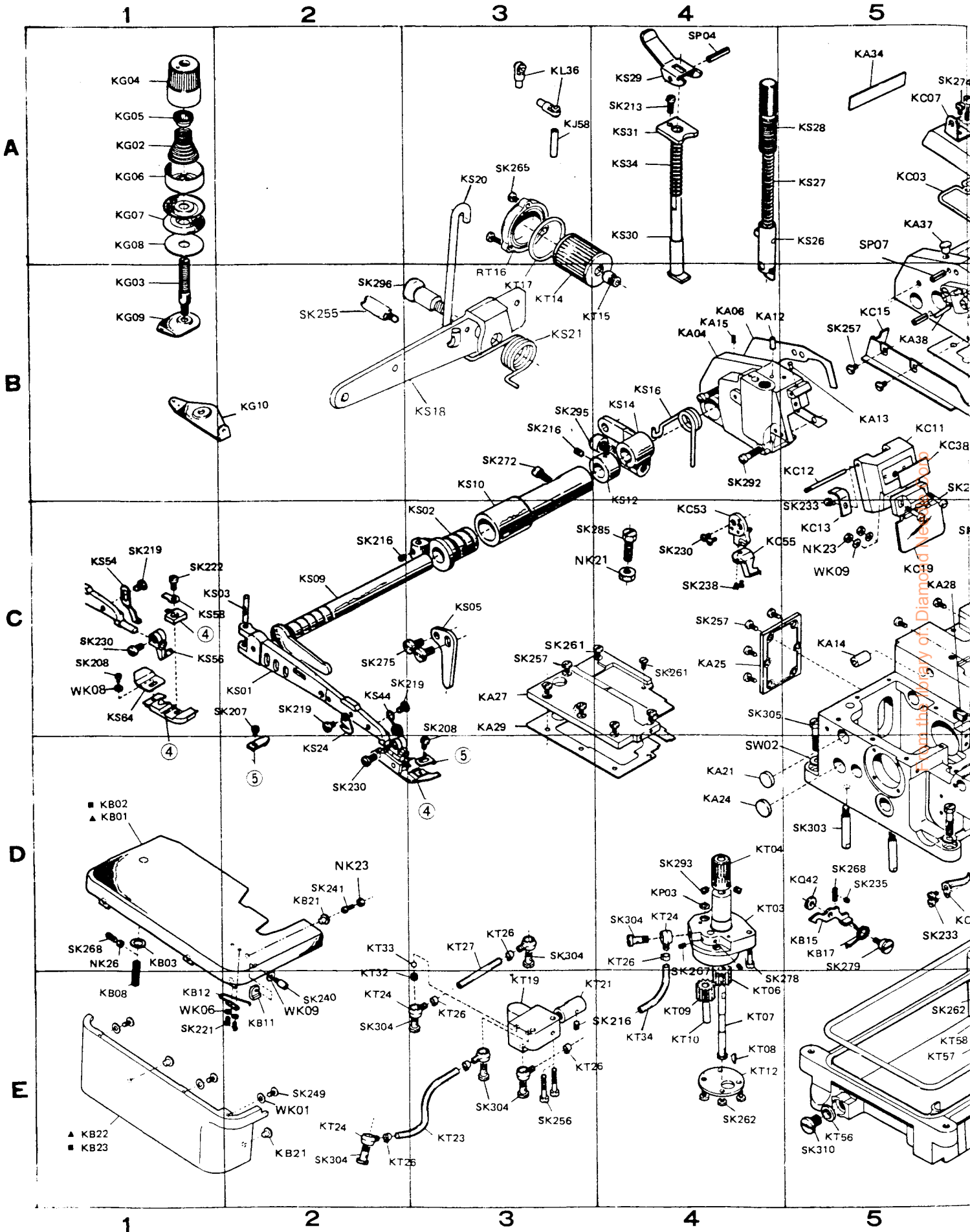

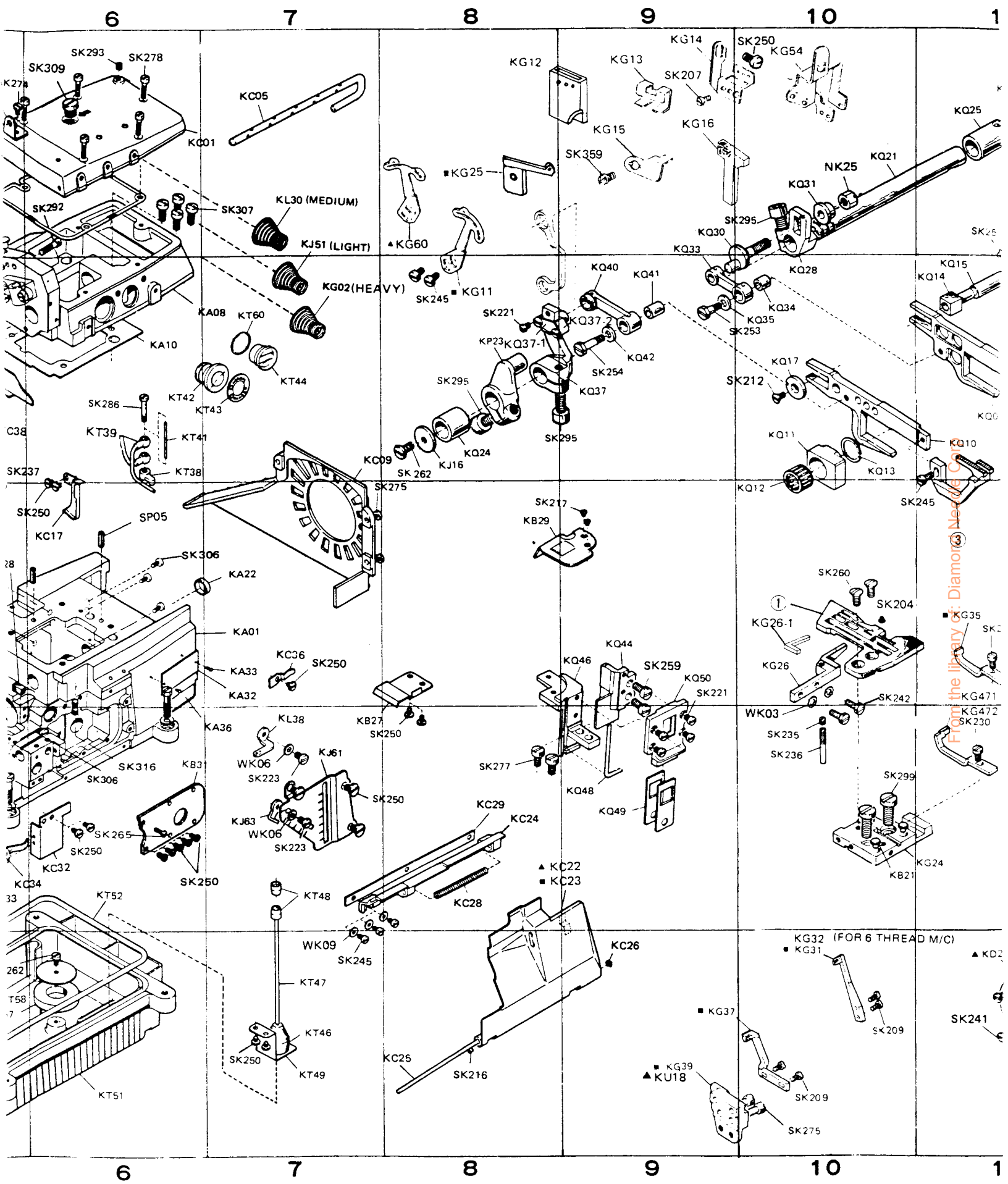

From the library: Diamoro Needles Co.

12

13

14

15

16

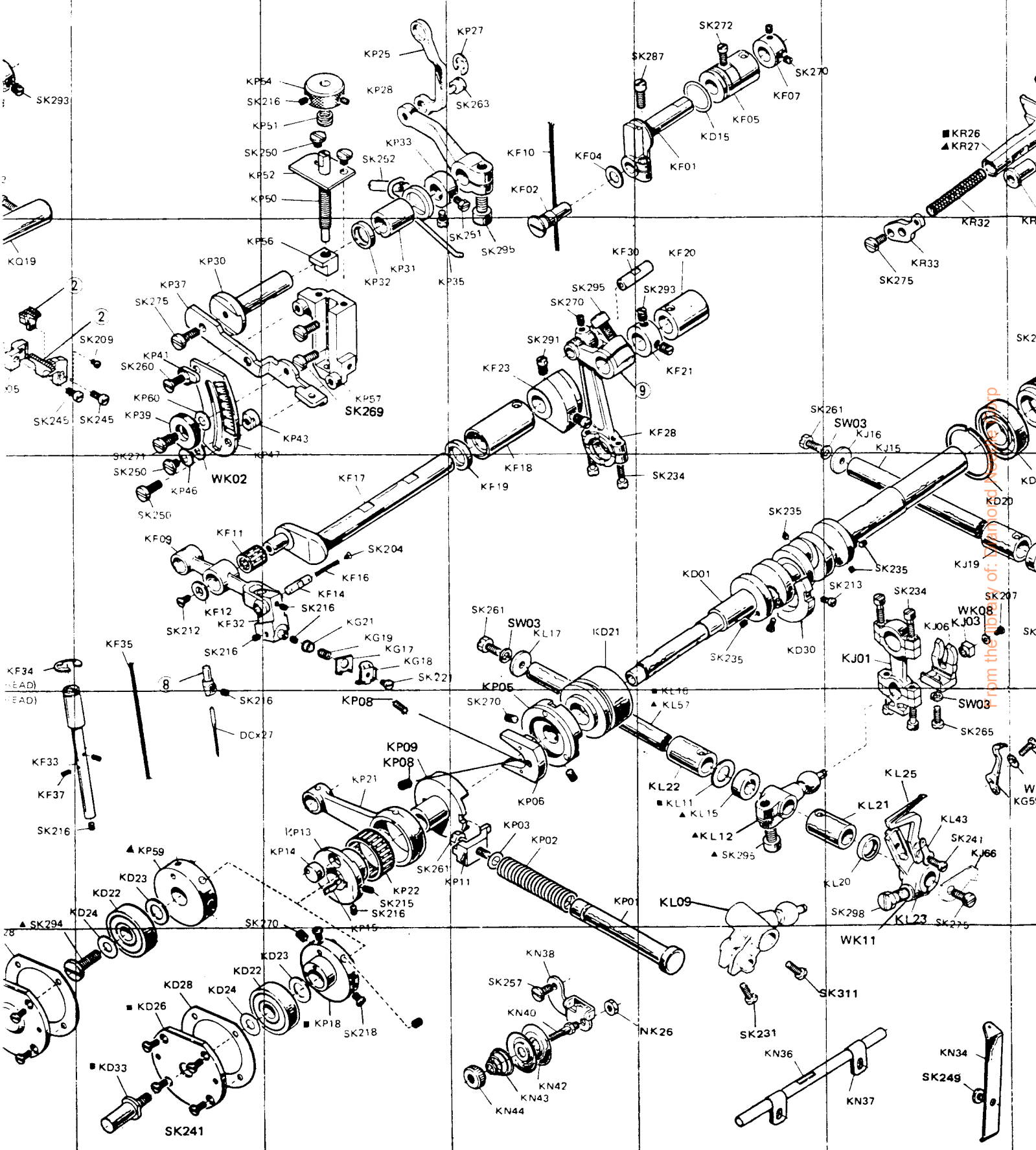

12

13

14

15

16

from the library of: Xarabod.com

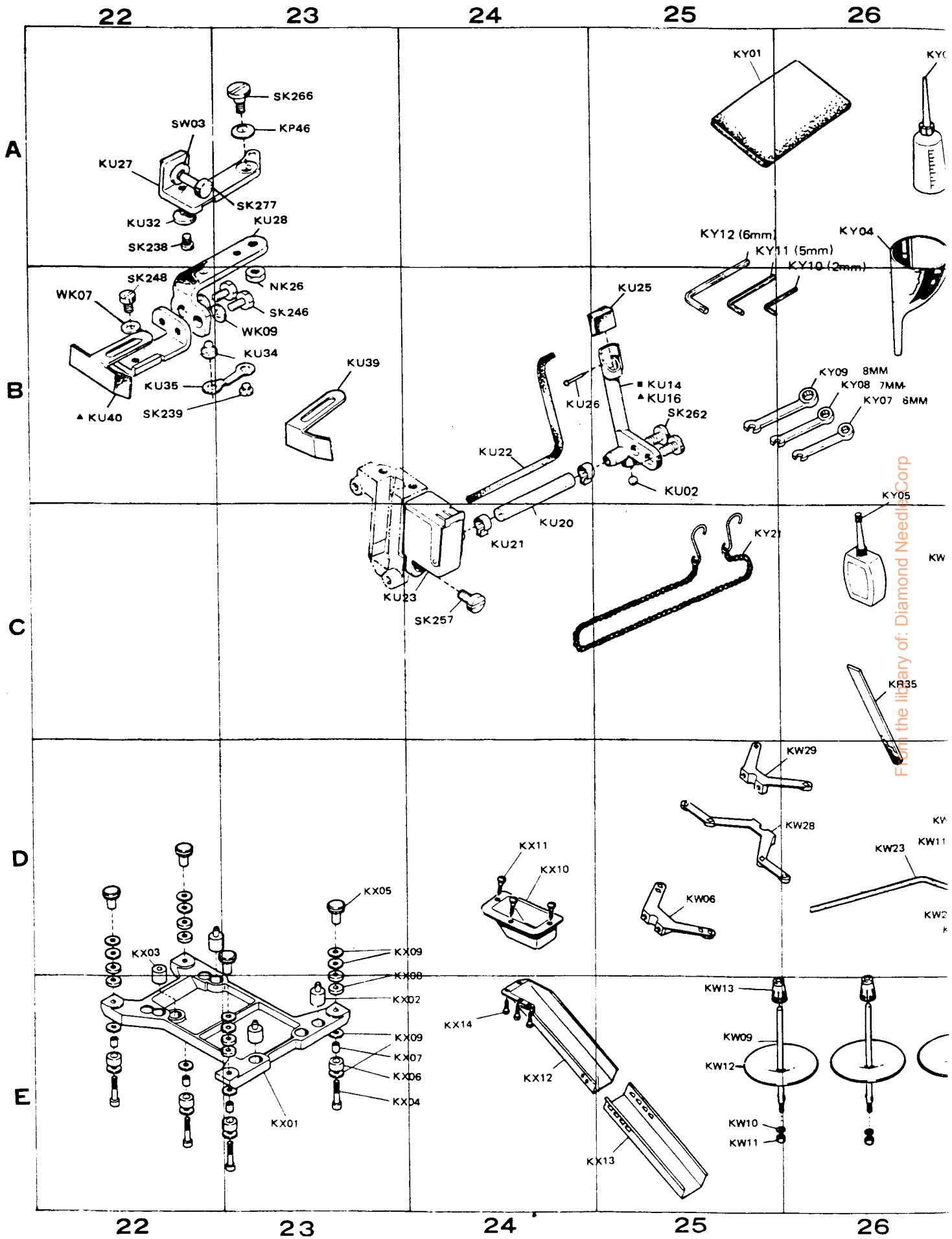

From the library of: Diamond Needle Corp

* PARTS FOR SEWING TYPE 505F1 ONLY

27

28

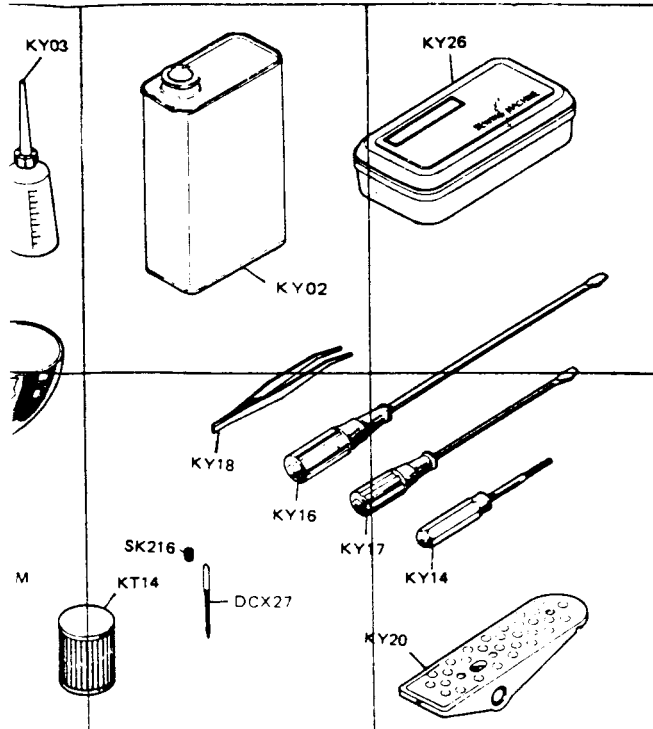

A
B

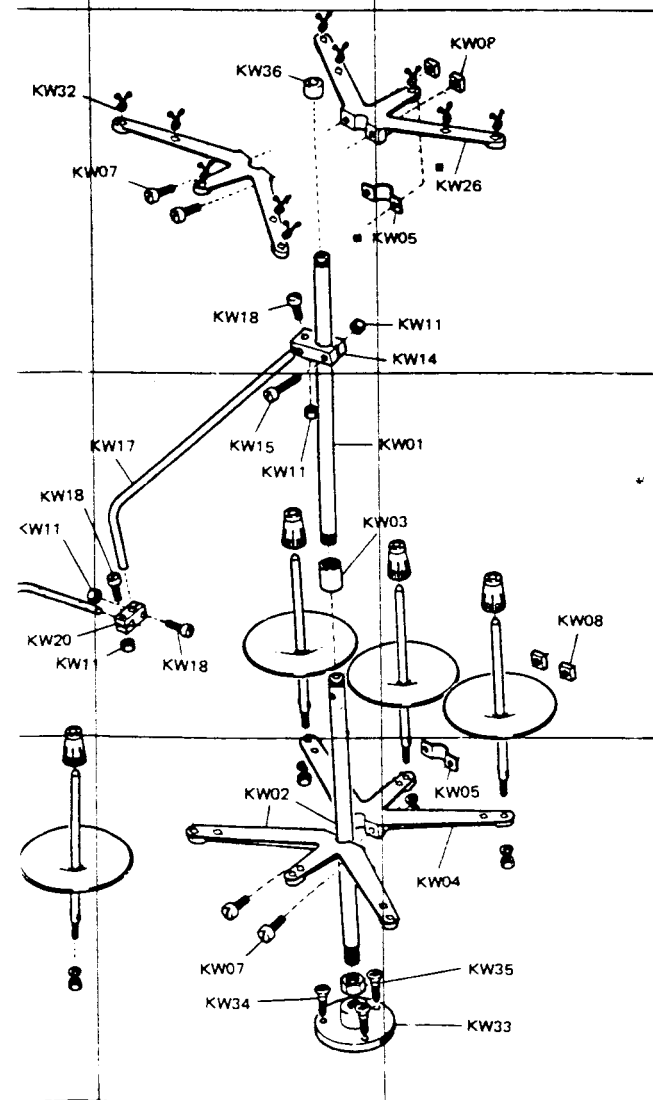

C
D
E

27

28

MODEL	GAUGE NG SM	NEEDLE PLATE ①	FEED COMP. MAIN + AUX. ②	DIFF. FEED DOG ③	SHAPE	PITCH	PRESS FOOT ④
861A-001-1	1.5	E934	(D290) D438 + D912	H442		1.6	P152E F5
861A-001-4	4	E800	(D574) D440 + D674	H445		1.6	P230C F3
861A-001-5	5	E797	(D574) D440 + D674	H445		1.6	P230C F3
861A-006-4BK	4	E589	(D390) D675 + D969	H974		1.6	AP9
861A-003-4	4	E784	(D569) D438 + D674	H442		1.6	P152E F1
862A-023-5	2 5	E810	(D575) D440 + D095	H445		1.6	P253 F3
862A-021-4 5	2 4 2 5	E809 E810	(D575) D440 + D095	H445		1.6	P253 P253
862A-022-3BK	2 3	E591	(D390) D675 + D969	H974		1.6	AP9
862A-033-4	2 4	E809	(D996) D958 + D095	H959		1.6	P152E F1
872A-061-4 063-5	2 4 3 5	E834 E839	(D579) D487 + D060	H492		1.6	P500 F3
872A-083-5	5 5	E851	(D581) D489 + D502	H494		1.6	P500 F3
872A-065-5	5 5	E851	(D582) D490 + D502	H495		2.5	P500 F3
872A-069-5	3 5	E982	(D002) D008 + D502	H957		1.6	P500 F3
872A-071-5	5 5	E986	(D003) D490 + D502	H957		1.6	P500 F3
872A-092-6	5 6	E854	(D582) D490 + D502	H495		2.5	P900 F3

- KA -	1E WK06 5D KB15	8D KC28 8D KC29 7E WK09	12E SK241 15C KD30 16C SK213	13C SK204	17D KG59 17D SK243 17D WK05
7C KA01 6D SK306 6C SK135 4B KA04 4B SK292 4B KA06	5D SK279 5D KB17 5D SK268 5D SK235 10D KB21	7E SK245 6D KC32 6D SK250 5D KC34 5D SK233	12E KD33	- KF -	2A KG01 1A KG02 1B KG03 1A KG04 1A KG05 9A SK359 1A KG06 9A KG16 1A KG07 1A KG08 9A SK207 2B KG10 10A KG54 10A SK250
5A KA07 6B KA08 7A SK307 6B KA10 6C KA11	1E KB22 1E KB23 2E SK249 2E WK01 2E KB26	7C KC36 7C SK250 5B KC38 4C KC53 4C SK230 4C KC55 5C SK238	15A KF01 14A KF02 15A SK287 14A KF04 15A KF05	15A SK272 15A SK272 15A KF07 18D KF07 15A SK270	8B KG11 8B SK245 12C SK216 12D DCX27 27B DCX27
4B KA12 5B KA13 5C KA14 4B KA15 5D SK303	7D KB27 8D SK250 8C KB29 9C SK217 6D KB31	4C SK230 4C KC55 5C SK238	- KD -	15C KD01 15C SK235 19A SK302 19A KD04 19A KD05	12C KF09 14A KF10 12C KF11 12C KF12 12C SK212
4D KA21 7C KA22 4D KA24 4C KA25 4C SK257	6D SK265 10D SK240	- KC -	18B KD09 18A KD10 17B KD12 18B SK274 17B KD13	13C KF14 13C SK216 13C KF16 13C KF17 14B KF18	13C KG21 10C SK260 11D KG24 10D SK299 10C KG26
3C KA27 3C KA28 3C KA29 3C SK257 4C SK261	6A KC01 6A SK278 5A KC03 6A SK309 7A KC05	6A SK293 5A KC07 5A SK274 6B KC09 7C SK275	17B KD14 17B KD15 15A KD15 17B KD16 17B KD17	20A KF19 14C KF19 15B KF20 15B KF21 21A KF21	13C SK221 18B KJ06 16C KJ06 18C SK265 18C SW03 17C KJ09
7C KA32 7C KA33 5A KA34 7D KA36 5A KA37	6A SK293 5A KC07 5A SK274 6B KC09 7C SK275	5B KC11 5B KC12 5C KC13 5C SK233 5B CK15	17B SK270 17B KD19 16C KD20 14C KD21 12E KD22	11A KF21 15B SK293 14B KF23 15B SK234 14B KF30	10C KG26-1 10C SK242 10C WK03 10D SK236 10D SK235
5B KA38	5B SK257 6C KC17 6C SK250 5C KC19 5B SK237	12D KD22 13E KD23 12D KD23 12E KD24 12D KD24	14B KF26 14B SK295 15B KF28 15B SK234 14B KF25	10D KG31 10E SK209 10E KG33 10E SK209 11C KG35	17C KJ10 17C KJ11 17C KJ12 17C SK295 16B KJ15
- KB -	1D KB01 1D KB02 1D KB03 2D SK241 2D NK23	5B SK257 6C KC17 6C SK250 5C KC19 5B SK237	12D KD22 13E KD23 12D KD23 12E KD24 12D KD24	14B KF26 14B SK295 15B KF28 15B SK234 14B KF30	16B KJ16 8B KJ16 16B SK261 16B SW03 16C KJ19
1D SK268 1D NK26 1E KD06 2E SK240 2E WK09	1D KB01 1D KB02 1D KB03 2D SK241 2D NK23	1D SK268 1D NK26 1E KD06 2E SK240 2E WK09	19A KD24 11D SK204 12E KD26 11E KD27 11D KD28	14B SK270 12C KF32 11D KF33 11C KF34 12C KF35	10E SK275 20E KJ26 20E KJ27 17C SK216 20E KJ29 20D KJ30
2E KB11 1E KB12 1E SK221	5B SK257 6C KC17 6C SK250 5C KC19 5B SK237	1D SK268 1D NK26 1E KD06 2E SK240 2E WK09	9E KC26 8E SK216	12E KD28 11E SK241	20D KJ31 20D KJ32

Hand Needs Cop

CODING SYSTEM

861A 001-4TG

(1) (2) (3) (4)

- (1) BASIC MACHINE
 a. 861A: SINGLE NEEDLE, 3 THREAD.
 b. 862A: TWO NEEDLE, 4 THREAD.
 c. 872A: TWO NEEDLE, 5 THREAD.

- (2) SUB-CLASS
 (3) OVEREDGE BIGHT
 (4) AVAILABLE DEVICE

- BK :BACK LATCHING DEVICE
 CT :PNEUMATIC (FLAT SUCTION) TYPE CHAIN CUTTER
 EC :ELECTRIC TYPE TAPE CUTTER
 ES :ELECTRIC HEMMING DEVICE
 GA :GATHERING DEVICE
 GB :GATHERING DEVICE (FOR TOP FEED MACHINE)
 LF-A:ELASTIC FEEDING DEVICE (ELECTRIC TYPE)
 LF-B:ELASTIC FEEDING DEVICE (MECHANIC TYPE)
 VT :PNEUMATIC (SIDE SUCTION) TYPE CHAIN CUTTER
 TG :TAPE GUIDE
 TU :VENTURI DEVICE
 FT :FRONT TOP-FEED MECHANISM
 RT :REAR TOP-FEED MECHANISM

FABRIC GUARD	UPPER LOOPER	SPREADER	NEEDLE HOLDER	NEEDLE DRIVE CRANK	UPPER LOOPER DRIVE CRANK	WASHER	NDL SIZE	FOOT LIFT mm	STH TYPE
KS62	LP22		KG131	KF25 STD	KJ09	KJ10	11	5.5	504
KS62	LP22		KG131	KF25 STD	KJ09	KJ10	9	5.5	504
KS62	LP22		KG131	KF25 STD	KJ09	KJ10	9	5.5	504
KS62	LP22		KG131	KF25 STD	KJ09	KJ10	9	5.5	504
C	LP22		KG131	KF25 STD	KJ09	KJ10	9	5.5	505
KS62	LP34		KG142	KF26 HI	KJ11	KJ13	14	6.0	512
KS62	LP24		KG142	KF26 HI	KJ11	KJ13	11	6.0	514
KS62	LP24		KG142	KF26 HI	KJ11	KJ13	11	6.0	514
	LP24		KG142	KF26 GA, HI	KJ11	KJ13	11	6.0	514
KS42	LP22 (LP21)		KG152 KG153	KF25 STD	KJ11	KJ10	11	5.5	516
KS42	LP24 (LP23)		KG155	KF25 STD	KJ11	KJ10	14	5.5	516
KS42	LP24 (LP23)		KG155	KF26 HI	KJ11	KJ12	16	6.0	516
KS42B	LP24 (LP23)		KG153 KG155	KF25 GA, STD	KJ11	KJ10	14	5.5	516
KS47	LP24 (LP23)		KG155	KF26 HI	KJ11	KJ12	21	6.0	514

SK270	16D KL23	18D KN08	13D KP13	- KQ -	9D KQ48	3B SK272	4E KT06	5E KT58	- KW -	24D KX10
KA21	16D KL25	18D SK295	13D KP14		9D KQ49	4B KS12	4E KT07			24D KX11
KJ35	16D WK11	19C KN10	13D KP15		12B SK209		4E KT08	5E SK262	27D KW01	24D KX12
	16D SK298		13D SK216		11B KQ05	3B SK216	4E KT09	7B KT60	28E KW02	25E KX13
	16D SK241		13D SK215		11B SK245	4B KS14	4E KT10		28D KW03	24E KX14
KJ36		18D KN11			11B SK245	3B SK295		- KU -	28E KW04	- KY -
KJ37	2A KL27	18D KN12			11B KW07	4B KS16	4E SK270		28E KW05	
KJ38	3A KL36	18D KN13	13E KP18			4C SK285	4E KT12	25B KU14	28C KW06	25A KY01
KJ39	7D KL38	18D SK251	13D SK270				4E SK262	25B KU16	27C KW07	26A KY03
KJ40	7D SK223	18D KN16	13E SK218		11B SK245	21B KR01	4B KT15		24C KU21	26B KY05
	7D WK06		13D KP21		11B KQ10	21A SK234			24C KU22	26B KY06
SK262		18D SK251	13D KP22		10B KQ11	4C NK21		25B SK262	24B KU20	26A KY07
KJ42	17D SK257	17E KN18			10B KQ12	3B KS18		9E KU18	27C KW07	26B KY07
SK300	16D SK275	17E SK216	8B KP23		10B KQ13	21A KR04			28D KW08	26B KY08
KJ44	17D KL46	18E KN20	8B SK295			2B SK296		3B KT16	24C KU21	
KJ45	15D KL57	18E SK233	13A SP25			3B KS22		3B KT17	24C KU22	
			14A SK263		11B KQ14	20A KR07		3A SK265	24B KU22	28C KW08
KJ46		19E KN22	14A KP27		11A KQ15	20A SK270		3E KT19	25E KW09	26A KY09
SK221	- KM -	19E SK201			11A SK251	20A KR09		3E SK256	25E KW10	26A KY11
KJ48		19E KN24	13A KP28		10B KQ17	20A KR12			24C KU23	25E KW11
KG51	21C KM01	18E SK264	14B SK295		10B SK212	20A KR13		3E KT21	24C SK257	25E KW11
KJ58	21C SK298	18E KN26	12B KP30			5A KS26		4E SK270	25B KU25	26D KW11
	21C SW01		13B KP31			5A KS27		3E KT22	24B KU26	27D KW11
SK216	21C KM04	19E KN27	13B KP32		11B KQ19	21A KR14		3E KT23	22A KU27	28C KW11
KJ61	21C SK230	19E SK250			11A SK272	21A SK293		3E KT24	23A KU28	28C KW11
SK250		19E KN29	13A KP33		10A KQ21	20B KR19		2E KT24	23A KU28	25E KW12
KJ63	21C KM06	19E SK238	14A SK251		8B SK262	20B KR20			23B KP46	25D KW13
SK223	21C SK209	19E WK09	14B KP35		8B KQ24	20B SK277		2E SK304	23B NK26	28C KW14
	20C KM08		13A SK252					3E KT26	23B NK26	26D KW17
WK06	20C SK295	17E KN32	12B KP37		11A KQ25	19B KR22		2E KT26	22A KU32	27D KW15
KJ66	20C SW01	17E SK250			11A SK293	20B KR23		4E KT26	23B KU39	26D KW17
KS275		16E KN34	12B SK275		10A KQ28	20B SK246		3D KT27	22A SW03	26D KW18
	20C KM11	16E SK249	12B KP39		10A SK295	20B KR25			22B KU40	26D KW20
KL -	20C KM12	15E KN36	12B SK271		9A KQ30	16A KR26		3C SK304	22B SK248	26D KW20
	20C SK251		12B SK271			16A KR27		4D SK304	22B WK07	26D KW23
KL01	20C KM15	16E KN37	12B KP41		10A KQ31	17A SK258		2E KT32	22B WK07	28C KW26
SK234	19C KM16	14E KN38	12B SK260		10A NK25	17A SK258		2D KT33	22B WK07	26C KW28
KL03		14E SK257	13B KP43		9A KQ33	17A KR29		4E KT34	22B WK07	26C KW29
WK08	21C KM17	14E KN40	12B SK250		10B KQ34	17A WK02			22B KU43	26C KW29
SK207	20C KM18	15E NK26	12B WK02		10B KQ35	17A SK256			23B WK09	26C KW32
SK265	19B KM20		12C KP46							28E KW33
SW03	19B SK270	14E KN42	12B KP47		10B SK253	16A KR32				27E KW34
KL09	19B KM22	14E KN43	12C KP46		9B KQ37	16B KR33				28E KW35
SK231		14E KN44	12C SK250		9B SK295	16B SK275				27C KW36
SK311	19C KM23				8B SK221	17A KR35				
KL11	18B KM24	- KP -	13A KP50		9A KQ40	26C KR35				
KL12	18B SK251		13A KP51			17A KR36				- KX -
SK295	18B NK27		13A KP52			17A SK261				23E KX01
KL15	- KN -									23E KX02
KL16			14D KP01							22E KX03
KL17	17E KN01		14D KP02							23E KX04
SK261	18D KN02		14D KP03							23D KX05
SW03	17E KN03		14C KP05							
KL20	17D SK205		14C SK270							
KL20	17D KN05									
KL21	18D WK04									
KL22	18D NK25									

From the library of: Diamond Needle Corp